

STEREO INTEGRATED AMPLIFIER

# KA-2050R/3050R

## SERVICE MANUAL

# KENWOOD

©1992-6 PRINTED IN JAPAN  
B51-4546-00 (S) 2349

(KA-2050R)

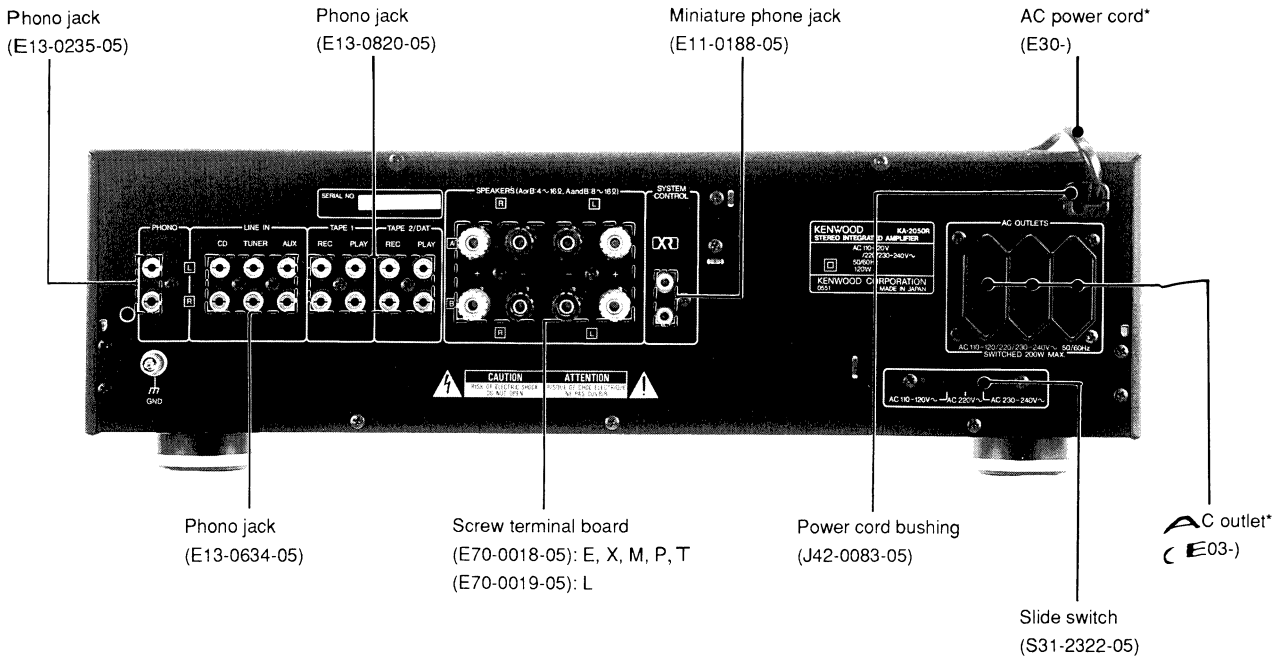
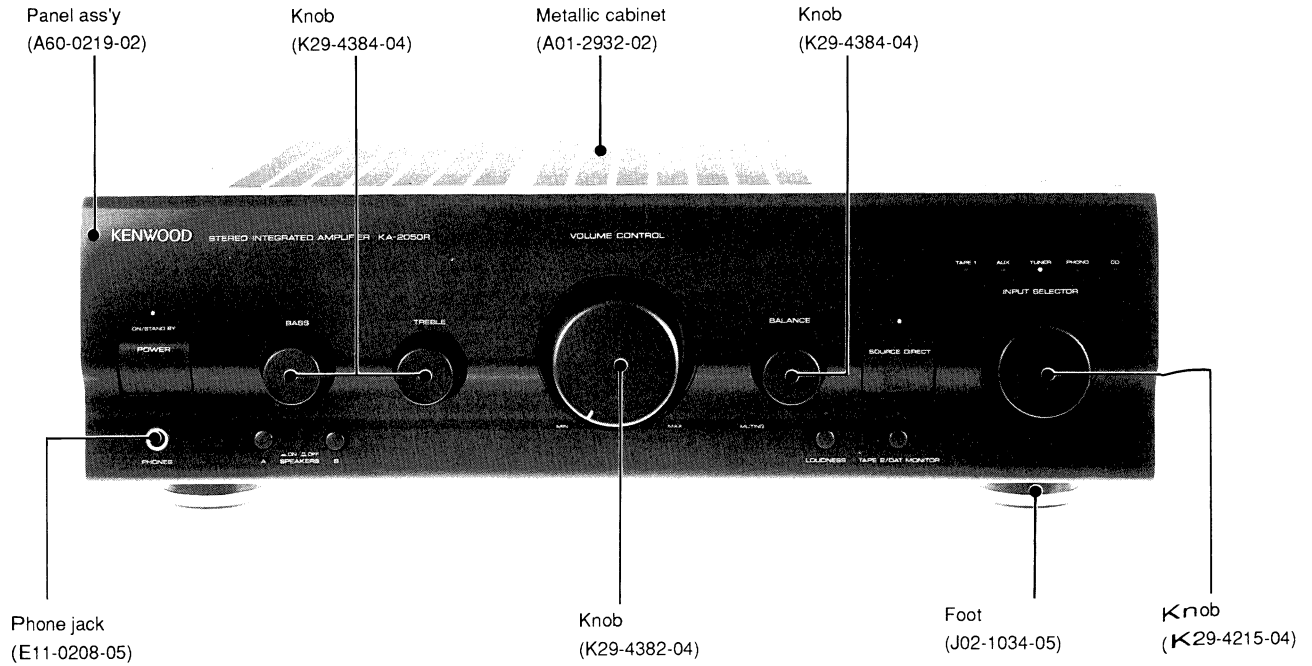

\* Refer to parts list on page 17.

# KA-2050R/3050R

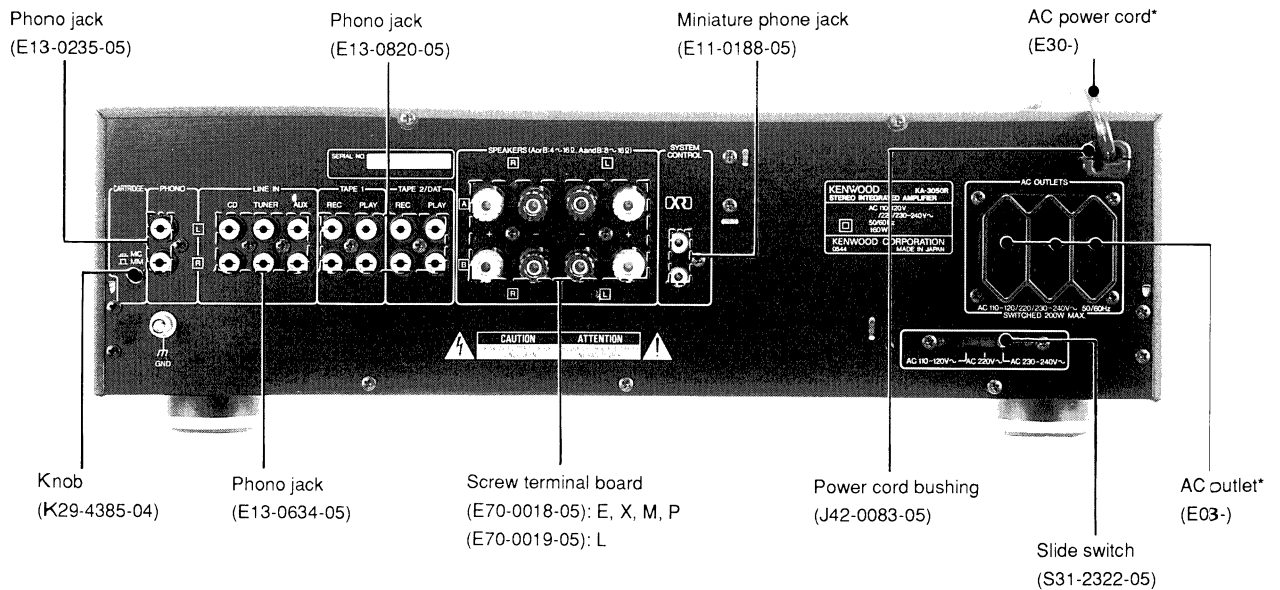
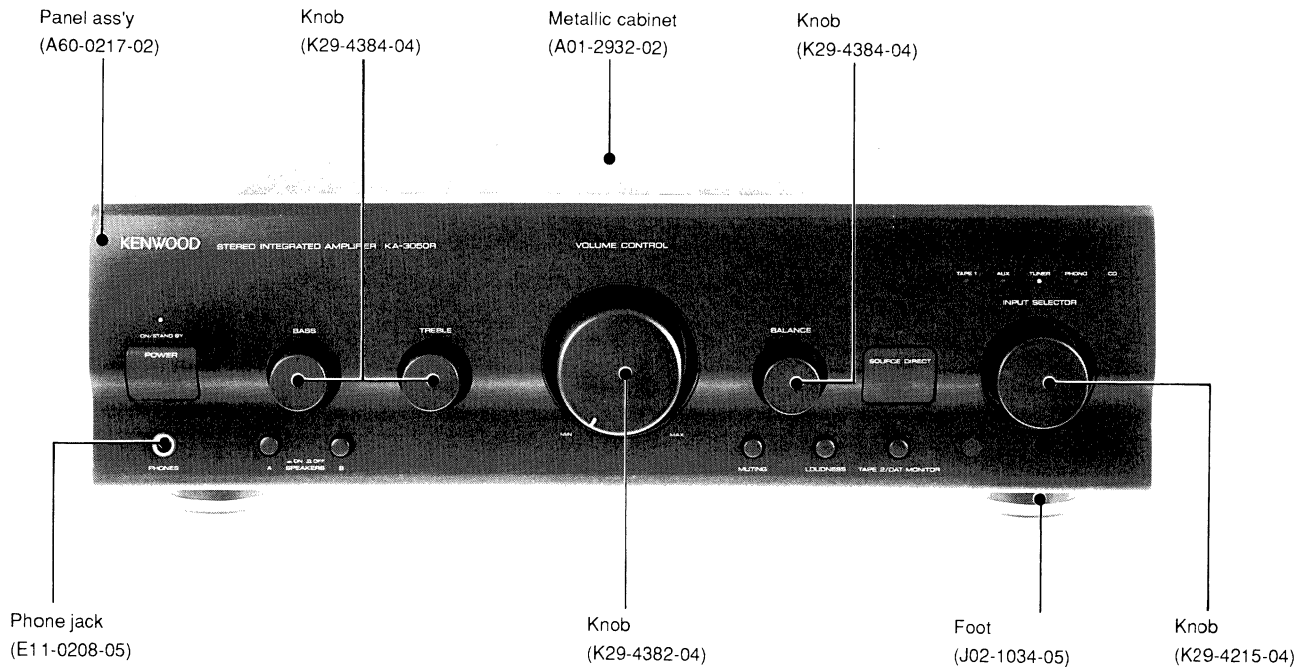

\* Refer to parts list on page 17.

## Accessories

- Remote control unit .... 1

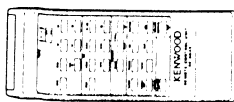

(A70-0597-05)  
(A09-0094-08) : Battery cover

- Batteries (R03/UM-4/ 'AAA') ..... 2

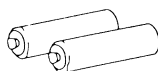

- AC plug adaptor ..... 1  
(Except for some areas)  
For the unit with a European AC plug in areas other than Europe.

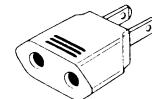

(E03-0115-05)

## ADJUSTMENT/REGLAGES/ABGLEICH

### ADJUSTMENT

No.	ITEM	INPUT SETTINGS	OUTPUT SETTINGS	AMPLIFIER SETTING	ALIGNMENT POINTS	ALIGN FOR	FIG.
Unless otherwise specified, set the respective switches as follows: POWER: ON SPEAKER: B REC OUT: OFF SELECTOR: PHONO							
1	IDLE CURRENT	-	Connect a DC voltmeter across CP1 (L) CP2 (R) (X09-)	VOLUME: 0	VR1 (L) VR2 (R) (X09-)	8.8 mV	(a)

### REGLAGES

N	ITEM	REGLAGE DE L'ENTREE	REGLAGE DE LA SORTIE	REGLAGE DE L'AMPLIFICATEUR	POINTS DE L'ALIGNMENT	ALIGNER POUR	FIG.
Sauf indication contraire, régler comme suit les commandes respectives: POWER: ON SPEAKER: B REC OUT: OFF SELECTOR: PHONO							
1	COURANT DE POLARISATION	-	Connecter un voltmètre de CC SUR CP1 (G) CP2 (D) (X09-)	VOLUME: 0	VR1 (G) VR2 (D) (X09-)	8.8 mV	(a)

### ABGLEICH

NR.	GENGENSTAND	EINGANGS-EINSTELLUNG	AUSANG-EINSTELLUNG	VORSTÄRKER-EINSTELLUNG	ABGLEICHE-PUNKTE	ABGLEICHEN FÜR	ABB.
Wenn nicht anders angegeben, die einzelnen Schalter wie folgt einstellen: POWER: ON SPEAKER: B REC OUT: OFF SELECTOR: PHONO							
1	LEERLAUFSTROM	-	Einen Gleichspannungsmesser über CP1 (L) CP2 (R) anschließen. (X09-)	VOLUME: 0	VR1 (L) VR2 (R) (X09-)	8.8 mV	(a)

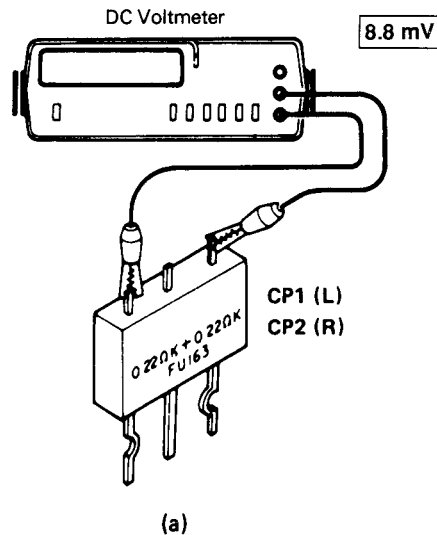

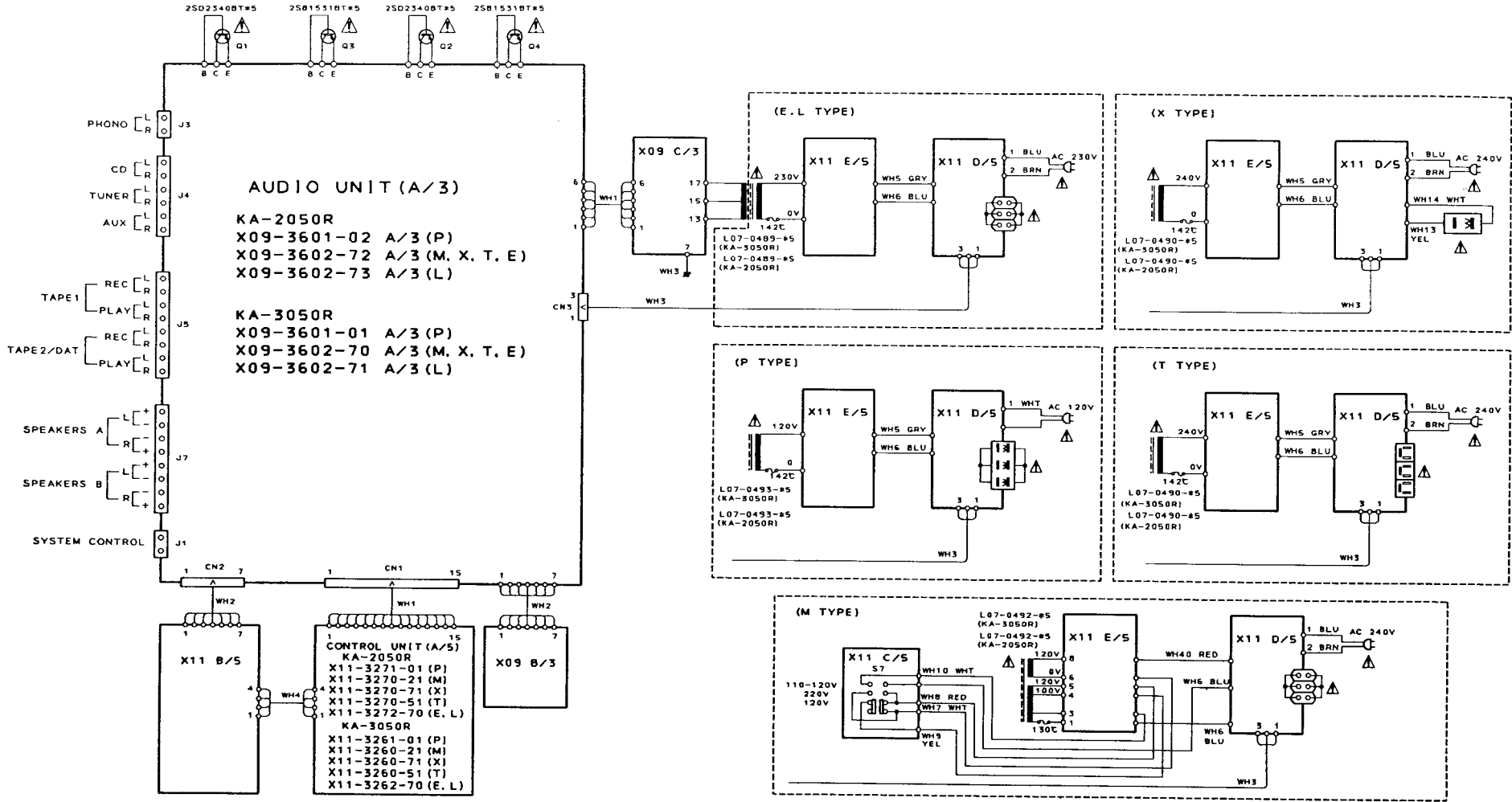

# PC BOARD (Component side view)

AUDIO UNIT

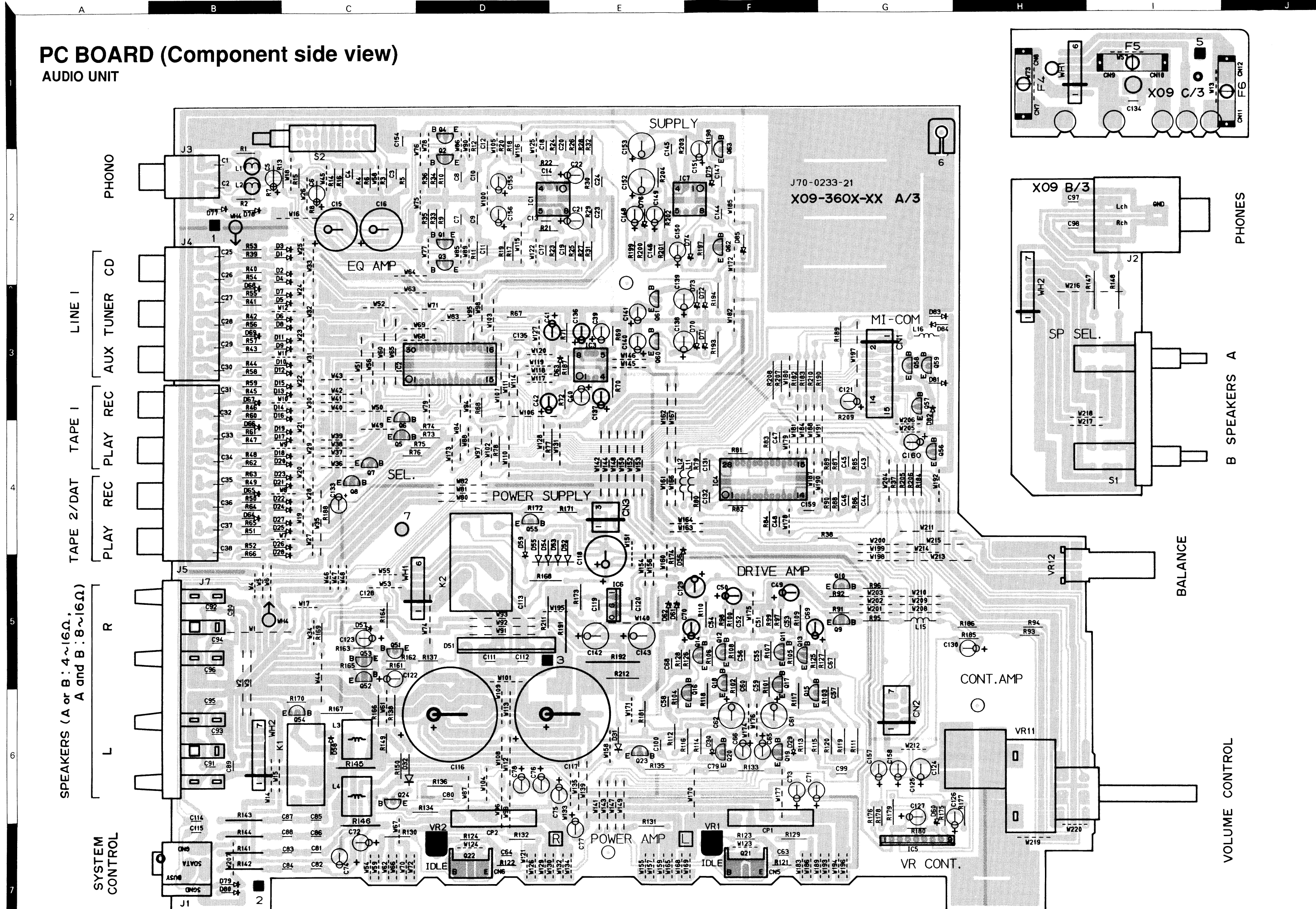

# PC BOARD (Component side view)

CONTROL UNIT

AC230-240V~ AC220V~ AC110-120V~

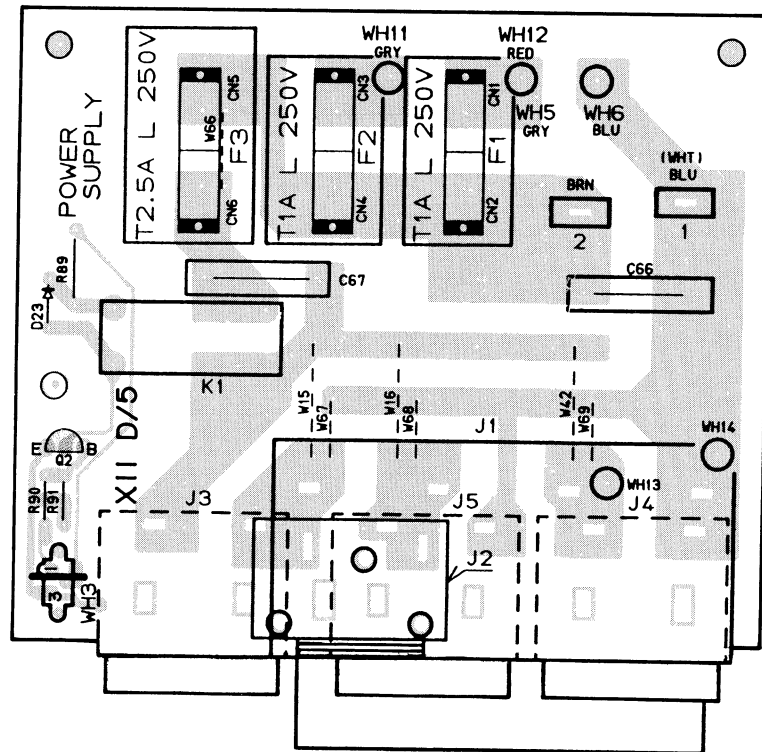
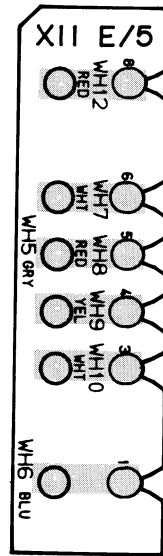
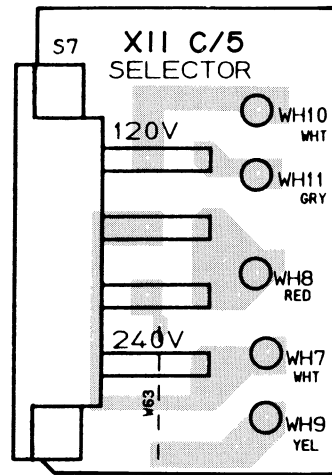

AC110-120/220/230-240V~ 50/60Hz  
SWITCHED 200W MAX

AC OUTLETS

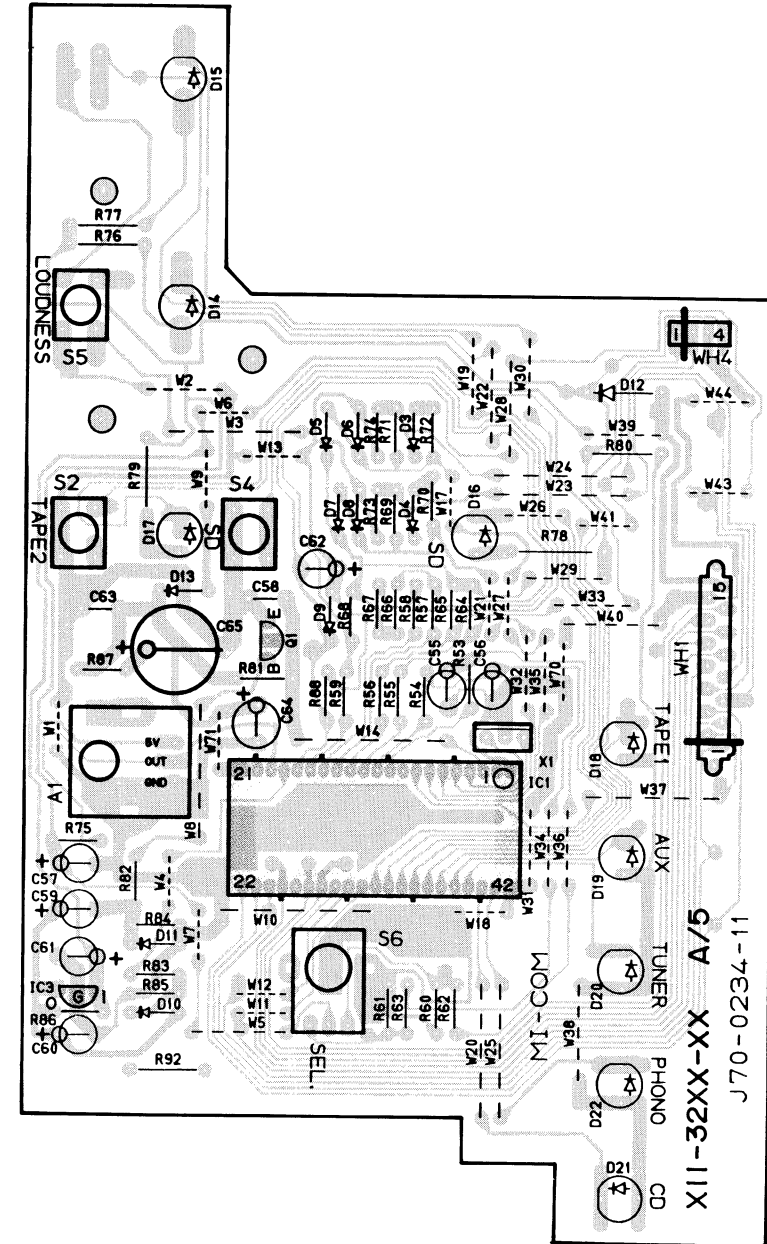
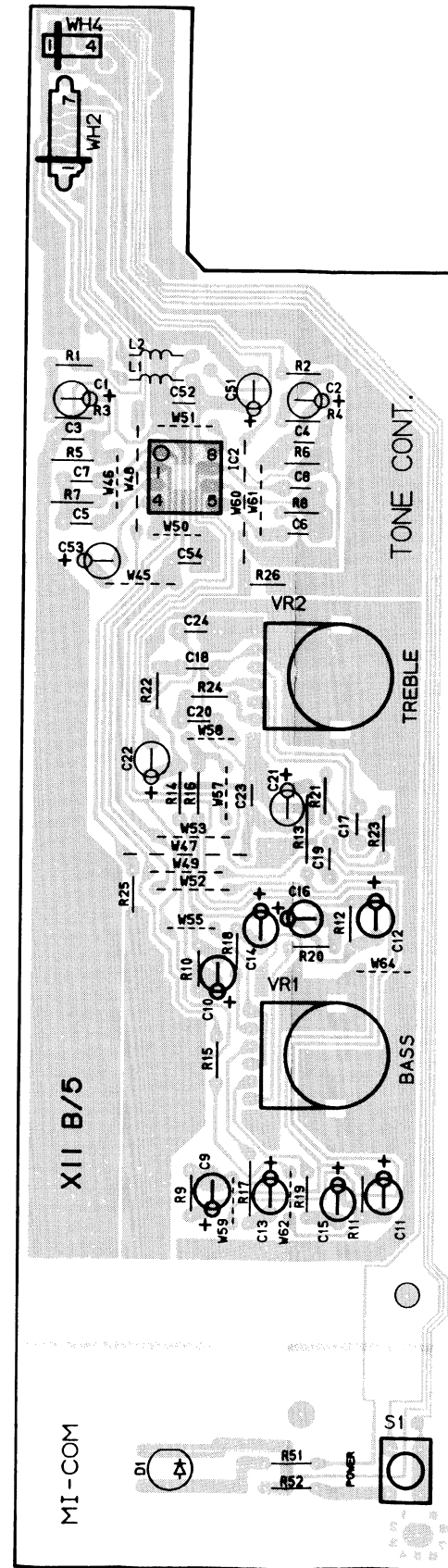

Refer to the schematic diagram for the values of resistors and capacitors.

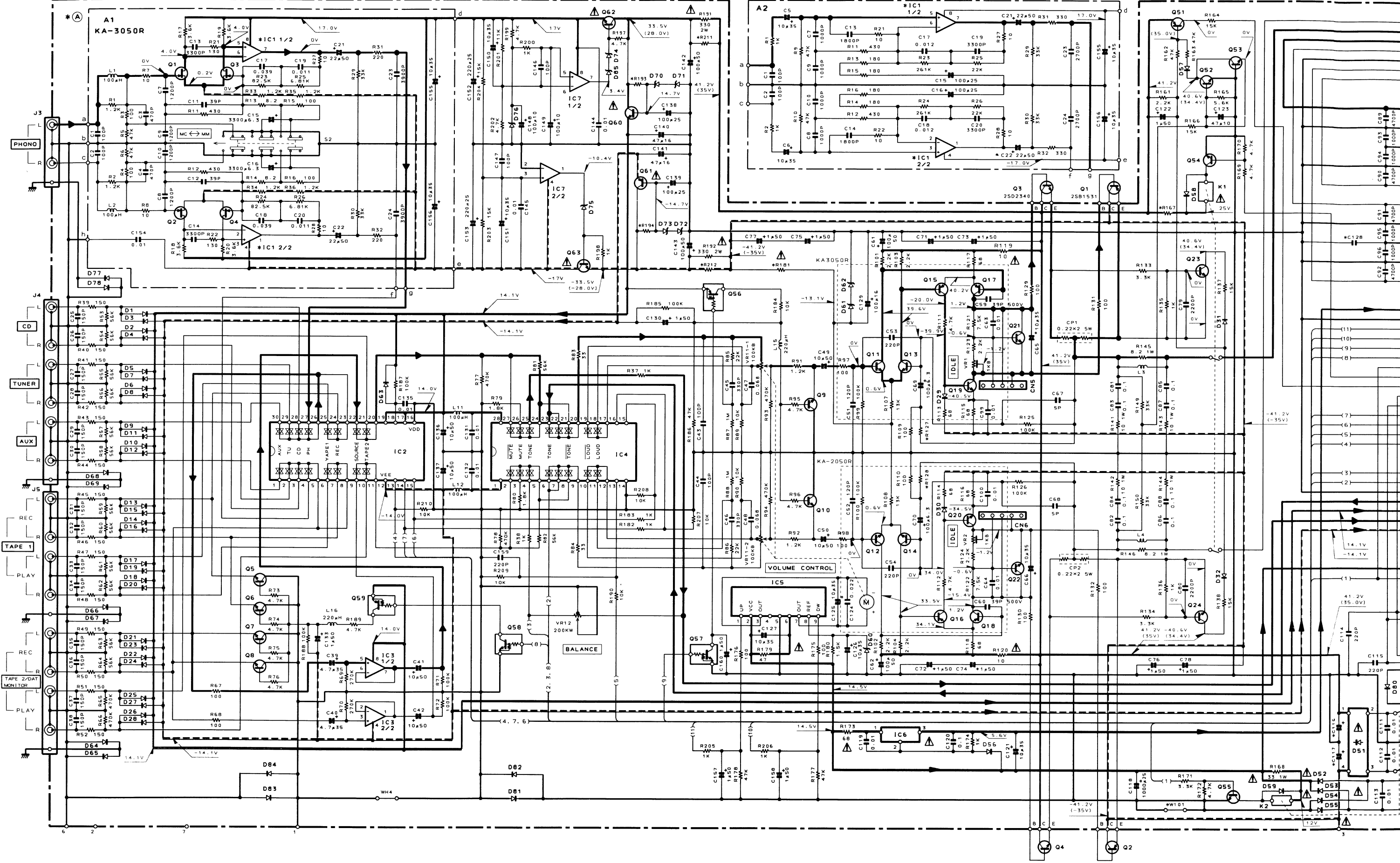

2  
3  
4  
5  
6  
7

(11)  
(10)  
(9)  
(8)  
(7)  
(6)  
(5)  
(4)  
(3)  
(2)

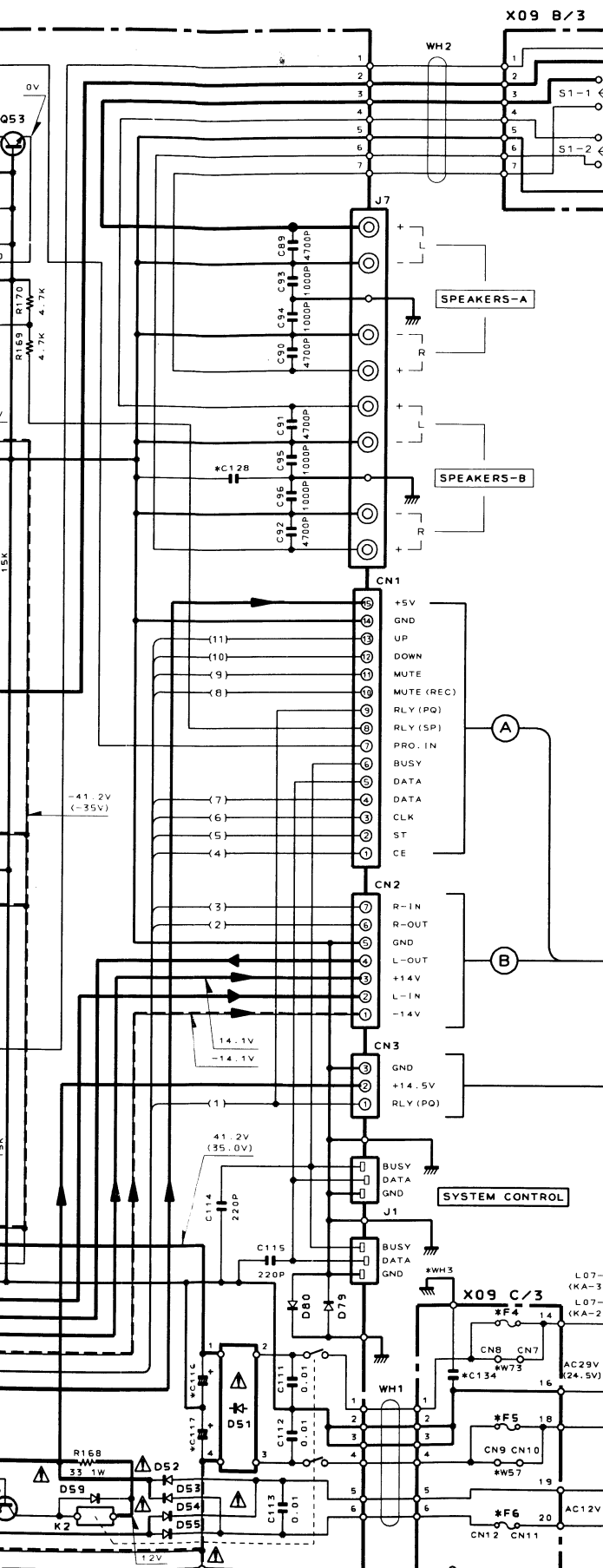

X09-360X-XX

COUNTRY	KA-3050R			KA-2050R		
	OTHER AREAS (M) AUSTRALIA (X) ENGLAND (T) EUROPE (E)	SCANDINAVIA (L)	CANADA (P)	OTHER AREAS (M) AUSTRALIA (X) ENGLAND (T) EUROPE (E)	SCANDINAVIA (L)	CANADA (P)
UNIT NAME	X09-3602-70	X09-3602-71	X09-3601-01	X09-3602-72	X09-3602-73	X09-3601-02
REF. NO						
(A)	A1	A1	A1	A2	A2	A2
IC1	NJM4565D	NJM4565D	NJM4565D	NJM4580D-D	NJM4580D-D	NJM4580D-D
C116, 117	6800µ50	6800µ50	6800µ50	5600µ42	5600µ42	5600µ42
C128, 134	0.01	0.01	NO	0.01	0.01	NO
R127, 128	11K	11K	11K	9.1K	9.1K	9.1K
R167	820 1W	820 1W	820 1W	470 1W	470 1W	470 1W
R181	3.9K	3.9K	3.9K	3.3K	3.3K	3.3K
R193, 194	4.7K	4.7K	4.7K	3.9K	3.9K	3.9K
R211, 212	820 1W	820 1W	820 1W	NO	NO	NO
F4, 5	NO	NO	6A 125V	NO	NO	5A 125V
F6	T1A L 250V	T1A L 250V	1A 250V	T1A L 250V	T1A L 250V	1A 250V
W18, 45, 58 75~78 89, 90, 115	YES	YES	YES	NO	NO	NO
W57, 73	YES	YES	NO	YES	YES	NO
W85, 86 122, 125	NO	NO	NO	YES	YES	YES
W101	NO	NO	YES	NO	NO	YES
WH3	YES	YES	NO	YES	YES	NO

- X09-360X-XX
- IC1 : NJM4565D (3050R)
  - IC2 : NJM4580D-D (2050R)
  - IC3 : NJM4580D-D
  - IC4 : TC9163N
  - IC5 : TA8409S
  - IC6 : PC7805AHF or TA7805S
  - IC7 : NJM4565D-D
- Q1~4 : 2SK170 (BL.V)
  - Q5~10 : 2SC2878 (B)
  - Q11~14 : 2SC1845 (F.E)
  - 19, 20
  - Q15~18 : 2SA992 (F.E)
  - Q21, 22 : 2SC4137 (V.W)
  - Q23, 24 : 2SC2458 (Y.GR)
  - 52, 53 or 2SC3311A (Q.R)
  - Q51 : 2SA1048 (Y.GR) or 2SA1309A (Q.R)
  - Q54, 55 : 2SC2003 (L.K)
  - Q56, 59 : UN4112 or DTA124ES
  - Q57, 58 : UN4212 or DTC124ES
  - Q60, 62, 63 : 2SD863 (E.F)
  - Q61 : 2SB764 (E.F)
  - D1~30, 56 : 1SS133
  - 57, 63~69, 77~84 or HSS104
  - D31, 32 : 1SS131
  - 58, 59 or HSS104A
  - D51 : RBV-602LFA or D5SBA20F03
  - D52~55 : S5688B
  - D60, 76 : RD5.1JS (B2)
  - D61, 62 : RD7.5JS (B)
  - 70~74, 85 or HZS7.5S (B2)
  - D75 : RD20JS (B) or HZS20S (B)

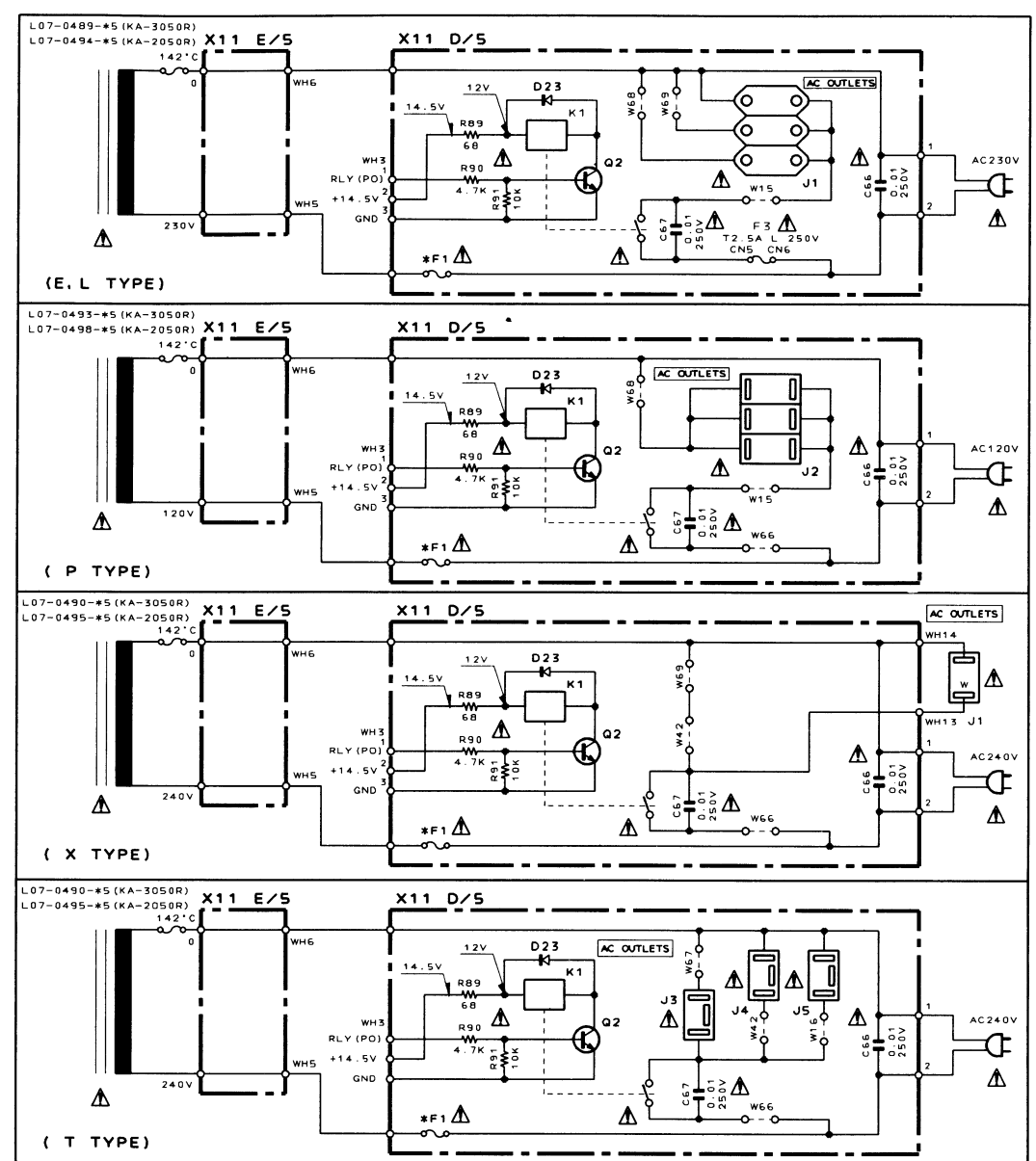
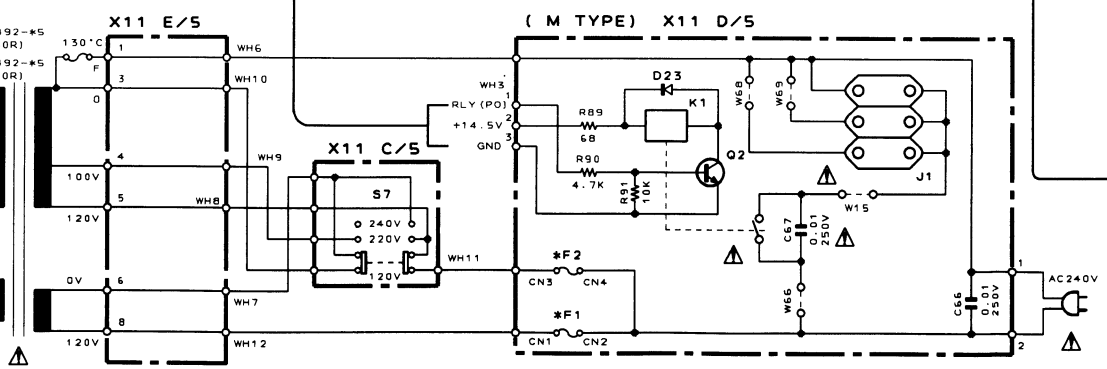

- X11-32XX-XX
- Q2 : 2SC2003 (L.K)
  - D23 : 1SS133 or HSS104

X11-32XX-XX

COUNTRY	ABB	KA-3050R			KA-2050R				
		UNIT NAME	REF. NO	F1	F2	UNIT NAME	REF. NO	F1	F2
CANADA	P	X11-3261-01	4A	125V	NO	X11-3271-01	2A	250V	NO
OTHER AREAS	M	X11-3260-21	T1.6A	L 250V	T1.6A	L 250V	X11-3270-21	T1A	L 250V
AUSTRALIA	X	X11-3260-71	T1.6A	L 250V	NO	X11-3270-71	T1A	L 250V	NO
ENGLAND	T	X11-3260-51	T1.6A	L 250V	NO	X11-3270-51	T1A	L 250V	NO
EUROPE, SCANDINAVIA	E.L	X11-3262-70	T1.6A	L 250V	NO	X11-3272-70	T1A	L 250V	NO

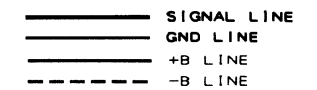

KA-2050R/3050R  
KENWOOD

Y08-4582-70



X11-32XX-XX A/5

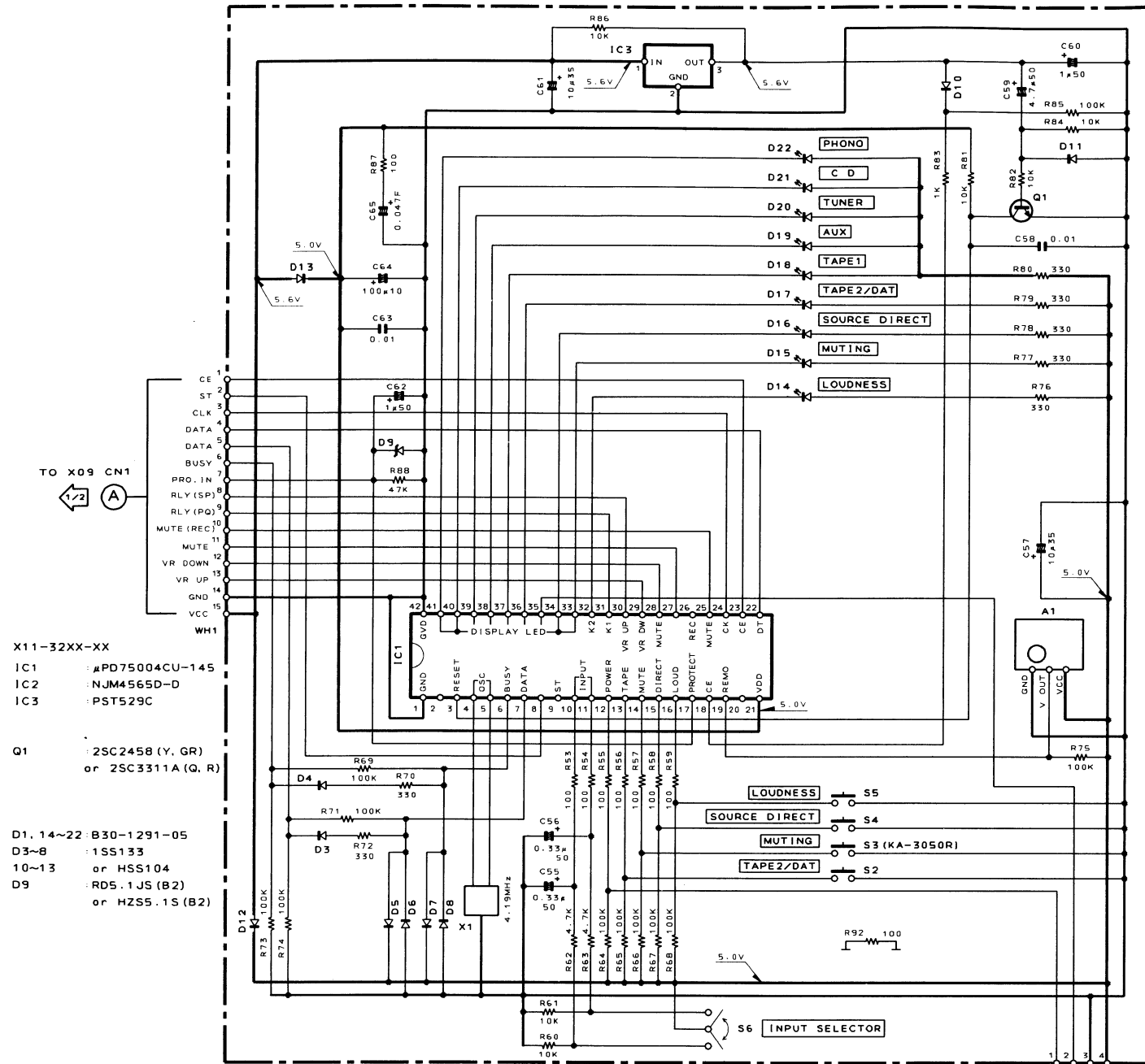

- X11-32XX-XX
- IC1 : PD75004CU-145
  - IC2 : NJM4565D-D
  - IC3 : PST529C
- Q1 : 2SC2458 (Y. GR)  
or 2SC3311A (Q. R)
- D1, 14-22 B30-1291-05  
D3-8 : 1SS133  
10-13 or HSS104  
D9 : RD5.1JS (B2)  
or HZS5.1S (B2)

X11 B/5

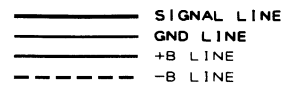
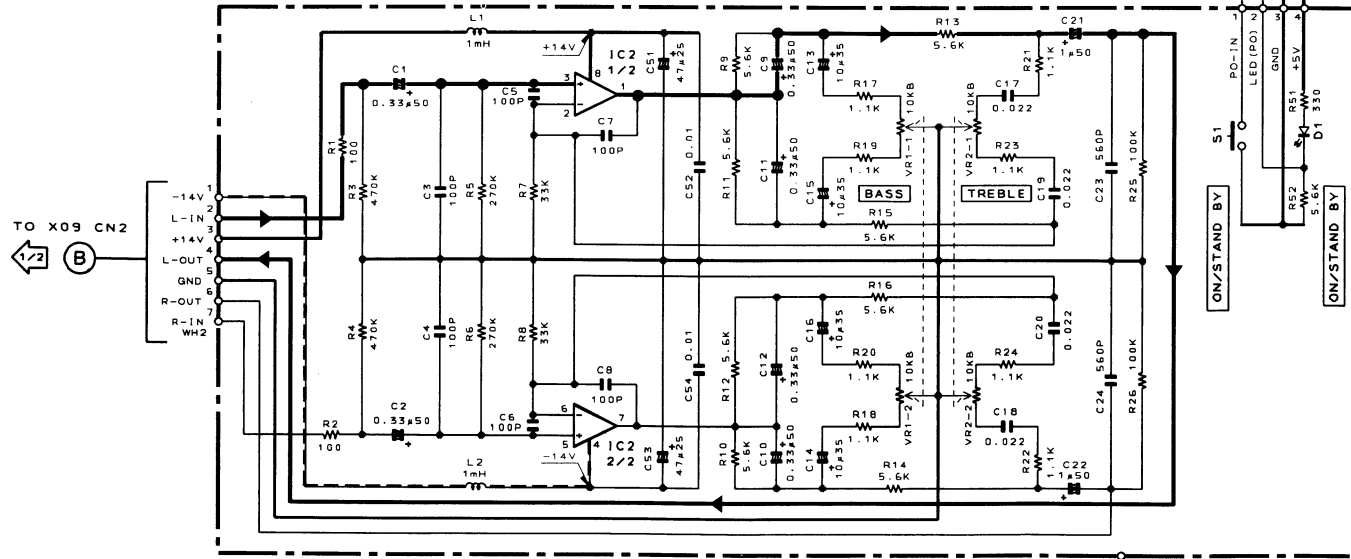

- HSS104
- HSS104A
- HZS5.1S
- RD5.1JS
- S5688B
- 1SS131
- 1SS133

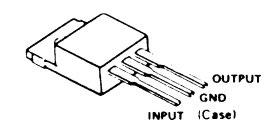

- 2SA992
- 2SB764
- 2SC1845
- 2SC2003
- 2SC2878
- 2SD863

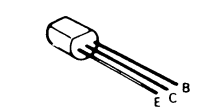

- 2SB1531BT\*5
- 2SD2340BT\*5

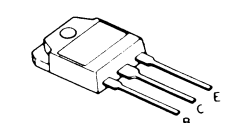

- DTA124ES
- DTC124ES
- UN4112
- 2SA1048
- 2SC2458

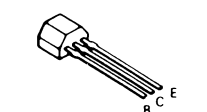

- 2SC4137

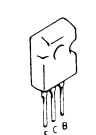

- UN4212
- 2SA1309A
- 2SC3311A

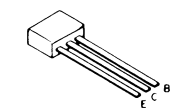

- NJM4565D
- NJM4565D-D

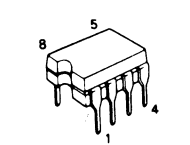

- TA8409S

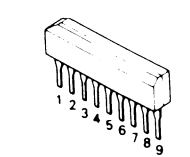

- NJM4580D-D

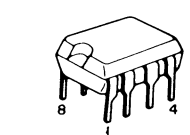

- UPD75004CU-145

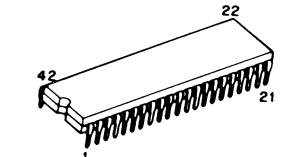

- PST529C

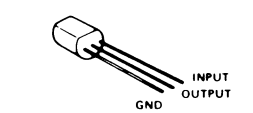

- 2SK170

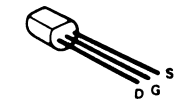

- LC7821N

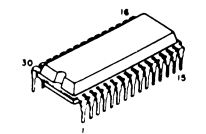

- TC9163N

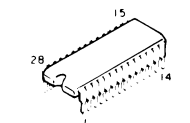

- TA7805S

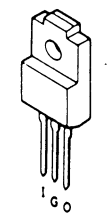

DC voltages are as measured with a high impedance voltmeter. Values may vary slightly due to variations between individual instruments or/and units.

Les tensions c.c. doivent être mesurées avec un voltmètre à haute impédance. Les valeurs peuvent différer légèrement du fait des variations inhérentes aux appareils et aux instruments de mesure individuels.

Die angegebenen Gleichspannungswerte wurden mit einem hochohmigen Spannungsmesser gemessen. Dabei schwanken die Meßwerte aufgrund von Unterschieden zwischen einzelnen Instrumenten oder Geräten u. U. geringfügig.

**CAUTION:** For continued safety, replace safety critical components only with manufacture's recommended parts (refer to parts list). *A*: Indicates safety critical components. To reduce the risk of electric shock, leakage-current or resistance measurements shall be carried out (exposed parts are acceptably insulated from the supply circuit) before the appliance is returned to the customer.

**KA-2050R/3050R**  
**KENWOOD**

Y08-4582-70

# REMOTE CONTROL OPERATION

# EXPLODED VIEW

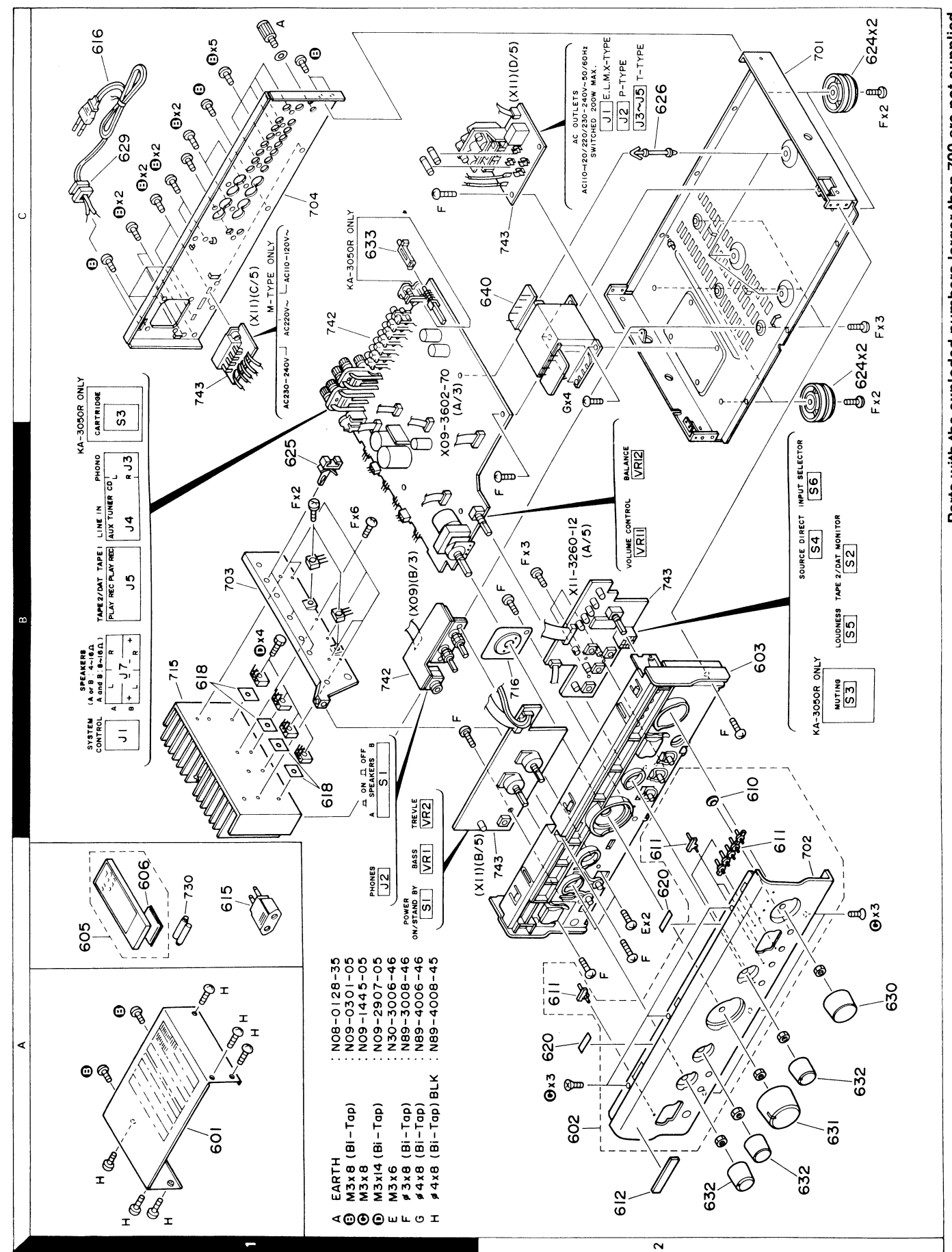
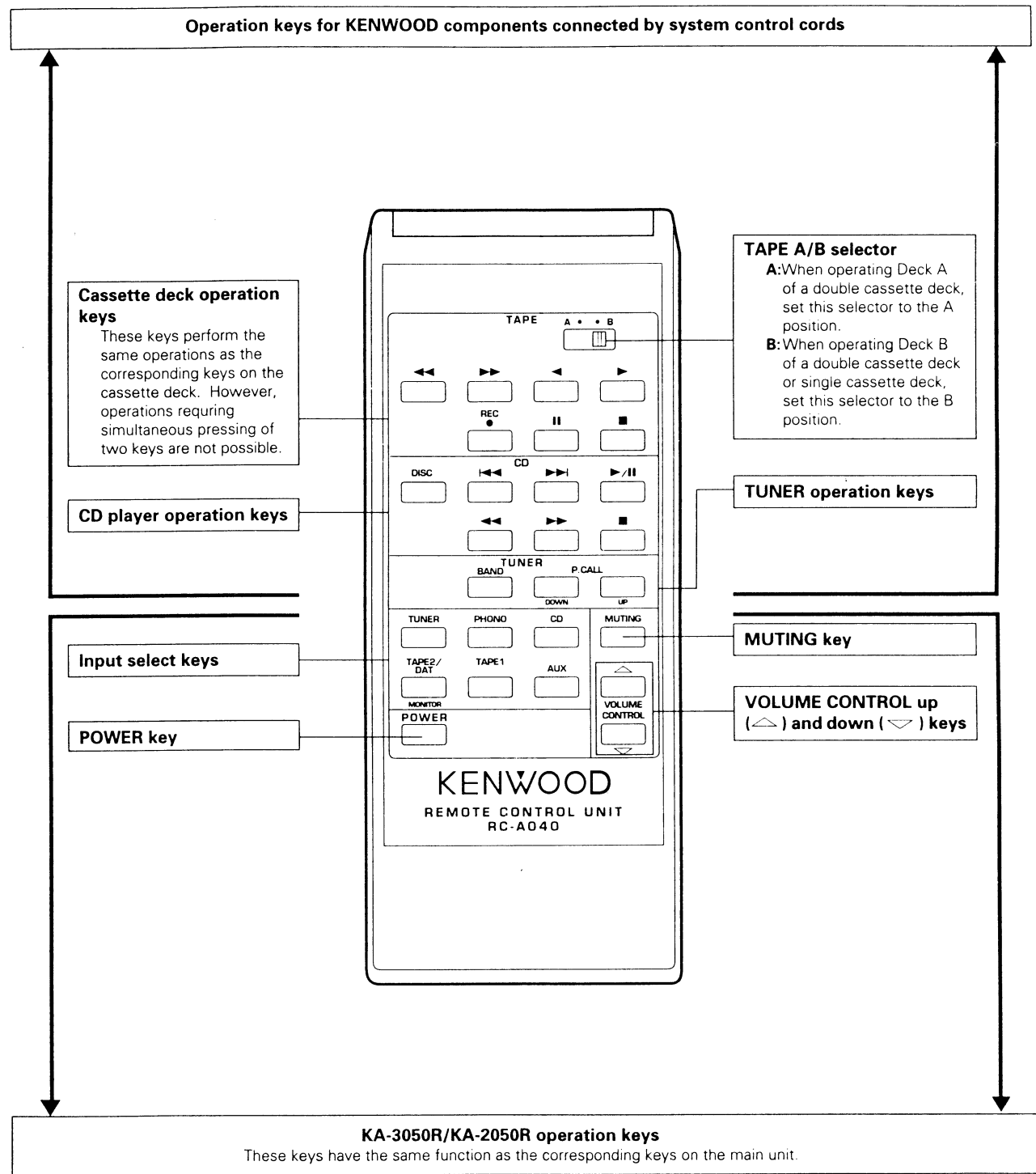

Parts with the exploded numbers larger than 700 are not supplied.

voltmeter.  
individual  
e à haute  
u fait des  
e mesure

mit einem  
schwanken  
einzelnen

critical  
s (refer to  
reduces the  
measurements  
ated from  
customer.

× New Parts

Parts without Parts No. are not supplied.

Les articles non mentionnés dans le Parts No. ne sont pas fournis.

Teile ohne Parts No. werden nicht geliefert.

No. 1

Ref. No.	Address	New	Parts No.	Description	Desti- nation	Re- marks
参照番号	位 置	新	部 品 番 号	部 品 名 / 規 格	仕 向	備 考
<b>KA-2050R</b>						
601	1A	*	A01-2932-02	METALLIC CABINET		
602	2A	*	A60-0219-02	PANEL ASSY		
603	2B	*	A22-1558-01	SUB PANEL		
605	1A	*	A70-0597-05	REMOTE CONTROLLER ASSY		
606	1A	*	A09-0094-08	BATTERY COVER		
610	2B		B11-0237-14	COLOR FILTER		
611	2A	*	B12-0196-04	INDICATOR		
612	2A		B43-0287-04	KENWOOD BADGE		
-	-		B46-0096-33	WARRANTY CARD	X	
-	-		B46-0121-13	WARRANTY CARD	P	
-	-		B46-0122-23	WARRANTY CARD	EL	
-	-		B46-0143-13	WARRANTY CARD	T	
-	-	*	B60-0835-00	INSTRUCTION MANUAL (ENGLISH)	ELP	
-	-	*	B60-0836-00	INSTRUCTION MANUAL (FRENCH)	EL	
-	-	*	B60-0837-00	INSTRUCTION MANUAL (GE,DU,IT)	EL	
-	-	*	B60-0965-00	INSTRUCTION MANUAL (CHINESE)	M	
-	-	*	B60-0966-00	INSTRUCTION MANUAL (SPANISH)	ELM	
△ 615	1A		E03-0115-05	AC PLUG ADAPTER	M	
△ 616	1C		E30-0459-05	AC POWER CORD	ELM	
△ 616	1C		E30-0974-05	AC POWER CORD	P	
△ 616	1C		E30-1341-05	AC POWER CORD	X	
△ 616	1C		E30-1416-05	AC POWER CORD	T	
△ J1	2C		E03-0114-05	AC OUTLET	X	
620	2A		G11-0153-04	SOFT TAPE (80X12X3)		
-	-	*	H50-0321-04	ITEM CARTON CASE		
-	-	*	H10-5296-02	POLYSTYRENE FOAMED FIXTURE		
-	-	*	H10-5297-02	POLYSTYRENE FOAMED FIXTURE		
-	-		H25-0225-04	PROTECTION BAG (850X450X0.03)	ELXMP	
-	-		H25-0232-04	PROTECTION BAG (235X350X0.03)	ELXMP	
-	-		H25-0651-04	PROTECTION BAG (0232 PRINTED)	T	
-	-		H25-0654-04	PROTECTION BAG (0225 PRINTED)	T	
624	2C		J02-1034-05	FOOT		
625	1B		J61-0033-05	WIRE BAND		
626	1C		J19-3331-05	UNIT HOLDER		
△ 629	1C		J42-0083-05	POWER CORD BUSHING		
-	-		J61-0307-05	WIRE BAND		
630	2A		K29-4215-04	KNOB INPUT SELECTOR		
631	2A	*	K29-4382-04	KNOB VOLUME CONTROL		
632	2A	*	K29-4384-04	KNOB BASS, TREBLE, BALANCE		
△ 640	2C	*	L07-0494-05	POWER TRANSFORMER	EL	
△ 640	2C	*	L07-0495-05	POWER TRANSFORMER	TX	
△ 640	2C	*	L07-0497-05	POWER TRANSFORMER	M	
△ 640	2C	*	L07-0498-05	POWER TRANSFORMER	P	
A	1C		N08-0128-35	BINDING POST (EARTH)		
B	1A, 1C		N09-0301-05	TAPTITE SCREW (3X8)		
C	2A		N09-1445-05	SET SCREW (M3X8)		
D	1B	*	N09-2907-05	SEMS (TAPTITE SCREW)(3X14)		
E	2A		N30-3006-46	PAN HEAD MACHINE SCREW		
F	1A, 1B		N89-3008-46	BINDING HEAD TAPTITE SCREW		
G	2C		N89-4006-46	BINDING HEAD TAPTITE SCREW		

L:Scandinavia K:USA P:Canada  
 Y:PX(Far East, Hawaii) T:England E:Europe  
 Y:AAFES(Europe) X:Australia M:Other Areas

3 : KA-3050R  
 2 : KA-2050R

△ indicates safety critical components.

### AUDIO UNIT

X09-3601-01	KA-3050R P
X09-3601-02	KA-2050R P
X09-3602-70	KA-3050R M, X, T, E
X09-3602-71	KA-3050R L
X09-3602-72	KA-2050R M, X, T, E
X09-3602-73	KA-2050R L

### CONTROL UNIT

X11-3260-21	KA-3050R M
X11-3260-51	KA-3050R T
X11-3260-71	KA-3050R X
X11-3261-01	KA-3050R P
X11-3262-70	KA-3050R E, L
X11-3270-21	KA-2050R M
X11-3270-51	KA-2050R T
X11-3270-71	KA-2050R X
X11-3271-01	KA-2050R P
X11-3272-70	KA-2050R E, L

PARTS LIST

KA-2050R/3050R

× New Parts  
 Parts without Parts No. are not supplied.  
 Les articles non mentionnés dans le Parts No. ne sont pas fournis.  
 Teile ohne Parts No. werden nicht geliefert.

No. 2

Ref. No. 参照番号	Address 位置	New Parts 新	Parts No. 部品番号	Description 部品名 / 規格	Desti- nation 仕向	Re- marks 備考
H	1A		N89-4008-45	BINDING HEAD TAPTITE SCREW		
Q1 ,2		*	2SB1531BT*5	TRANSISTOR		
Q3 ,4		*	2SD2340BT*5	TRANSISTOR		
<b>KA-3050R</b>						
601	1A	*	A01-2932-02	METALLIC CABINET		
602	2A	*	A60-0217-02	PANEL ASSY		
603	2B	*	A22-1559-01	SUB PANEL		
605	1A	*	A70-0597-05	REMOTE CONTROLLER ASSY		
606	1A	*	A09-0094-08	BATTERY COVER		
610	2B		B11-0237-14	COLOR FILTER		
611	2A	*	B12-0196-04	INDICATOR		
612	2A		B43-0287-04	KENWOOD BADGE		
-			B46-0096-33	WARRANTY CARD		
-			B46-0121-13	WARRANTY CARD	X	
-			B46-0122-23	WARRANTY CARD	EL	
-			B46-0143-13	WARRANTY CARD	T	
-		*	B60-0835-00	INSTRUCTION MANUAL (ENGLISH)		
-		*	B60-0836-00	INSTRUCTION MANUAL (FRENCH)	ELP	
-		*	B60-0837-00	INSTRUCTION MANUAL (GE,DU,IT)	EL	
-		*	B60-0965-00	INSTRUCTION MANUAL (CHINESE)	M	
-		*	B60-0966-00	INSTRUCTION MANUAL (SPANISH)	ELM	
△ 615	1A		E03-0115-05	AC PLUG ADAPTER	M	
△ 616	1C		E30-0459-05	AC POWER CORD	ELM	
△ 616	1C		E30-0974-05	AC POWER CORD	P	
△ 616	1C		E30-1341-05	AC POWER CORD	X	
△ 616	1C		E30-1416-05	AC POWER CORD	T	
J1	2C		E03-0114-05	AC OUTLET	X	
618	1B		F20-1322-05	INSULATING BOARD		
620	2A		G11-0153-04	SOFT TAPE (80X12X3)		
-		*	H50-0320-04	ITEM CARTON CASE		
-		*	H10-5296-02	POLYSTYRENE FOAMED FIXTURE		
-		*	H10-5297-02	POLYSTYRENE FOAMED FIXTURE		
-			H25-0225-04	PROTECTION BAG (850X450X0.03)		
-			H25-0232-04	PROTECTION BAG (235X350X0.03)	ELXMP	
-			H25-0651-04	PROTECTION BAG (0232 PRINTED)	T	
-			H25-0654-04	PROTECTION BAG (0225 PRINTED)	T	
624	2C		J02-1034-05	FOOT		
625	1B		J61-0033-05	WIRE BAND		
626	1C		J19-3331-05	UNIT HOLDER		
629	1C		J42-0083-05	POWER CORD BUSHING		
-			J61-0307-05	WIRE BAND		
630	2A		K29-4215-04	KNØB INPIUT SELECTØR		
631	2A	*	K29-4382-04	KNØB VOLUME CONTRØL		
632	2A	*	K29-4384-04	KNØB BASS, TREBLE, BALANCE		
633	1C	*	K29-4385-04	KNØB MM/MC		
△ 640	2C	*	L07-0489-05	POWER TRANSFORMER	EL	
△ 640	2C	*	L07-0490-05	POWER TRANSFORMER	TX	
△ 640	2C	*	L07-0492-05	POWER TRANSFORMER	M	
△ 640	2C	*	L07-0493-05	POWER TRANSFORMER	P	
A	1C		N08-0128-35	BINDING POST (EARTH)		

L:Scandinavia K:USA P:Canada 3: KA-3050R  
 Y:PX(Far East, Hawaii) T:England E:Europe 2: KA-2050R  
 Y:AAFES(Europe) X:Australia M:Other Areas △ indicates safety critical components.

× New Parts  
 Parts without Parts No. are not supplied.  
 Les articles non mentionnés dans le Parts No. ne sont pas fournis.  
 Teile ohne Parts No. werden nicht geliefert.

No. 3

Ref. No. 参照番号	Address 位置	New Parts 新	Parts No. 部品番号	Description 部品名 / 規格	Desti- nation 仕向	Re- marks 備考
B	1A, 1C		N09-0301-05	TAPTITE SCREW (3X8)		
C	2A		N09-1445-05	SET SCREW (M3X8)		
D	1B	*	N09-2907-05	SEMS (TAPTITE SCREW)(3X14)		
E	2A		N30-3006-46	PAN HEAD MACHINE SCREW		
F	1A, 1B		N89-3008-46	BINDING HEAD TAPTITE SCREW		
G	2C		N89-4006-46	BINDING HEAD TAPTITE SCREW		
H	1A		N89-4008-45	BINDING HEAD TAPTITE SCREW		
Q1 ,2		*	2SB1531BT*5	TRANSISTOR		
Q3 ,4		*	2SD2340BT*5	TRANSISTOR		
<b>AUDIO UNIT (X09-360X-XX)</b>						
C1 ,2			CF92FV1H101K	MF 100PF	K	
C3 ,4			CF92FV1H471J	MF 470PF	J	3
C5 ,6			CE04KW1V100M	ELECTRØ 100UF	35WV	2
C7 -10			CF92FV1H102J	MF 1000PF	J	2
C7 -10			CF92FV1H122J	MF 1200PF	J	3
C11 ,12			CC45FSL1H390J	CERAMIC 39PF	J	3
C13 ,14			CF92FV1H182J	MF 1800PF	J	3
C13 ,14			CF92FV1H332J	MF 3300PF	J	3
C15 ,16			CE04KW1E101M	ELECTRØ 100UF	25WV	2
C15 ,16			C90-1951-05	ELECTRØ 3300UF	6.3WV	3
C17 ,18			CF92FV1H123J	MF 0.012UF	J	2
C17 ,18			CF92FV1H393J	MF 0.039UF	J	2
C19 ,20			CF92FV1H113J	MF 0.011UF	J	2
C19 ,20			CF92FV1H332J	MF 3300PF	J	2
C21 ,22			CE04KW1H220M	ELECTRØ 22UF	50WV	2
C23 ,24			CF92FV1H272J	MF 2700PF	J	2
C23 ,24			CF92FV1H392J	MF 3900PF	J	3
C25 -38			CF92FV1H151K	MF 150PF	K	
C39 ,40			CE04KW1V4R7M	ELECTRØ 4.7UF	35WV	
C41 ,42		*	C90-1971-05	ELECTRØ 10UF	50WV	
C43 ,44			CF92FV1H101K	MF 100PF	K	
C45 ,46			CF92FV1H331K	MF 330PF	K	
C47 ,48			CF92FV1H683J	MF 0.068UF	J	
C49 ,50		*	C90-1971-05	ELECTRØ 10UF	50WV	
C51 ,52			CF92FV1H121K	MF 120PF	K	
C53 ,54			CF92FV1H221K	MF 220PF	K	
C59 ,60			CC45FSL2H390J	CERAMIC 39PF	J	
C61 ,62			CE04KW1H101M	ELECTRØ 100UF	50WV	
C63 ,64			CF92FV1H103J	MF 0.010UF	J	
C65 ,66			CE04KW1V100M	ELECTRØ 10UF	35WV	
C67 ,68			CC45FSL1H050C	CERAMIC 5.0PF	C	
C69 ,70		*	C90-1972-05	ELECTRØ 100UF	6.3WV	
C71 -78			CE04KW1H010M	ELECTRØ 1.0UF	50WV	
C79 ,80			CK45FB1H222K	CERAMIC 2200PF	K	
C81 -88			CF92FV1H104J	MF 0.10UF	J	
C89 -92			CF92FV1H472J	MF 4700PF	J	
C93 -98			CK45FB1H102K	CERAMIC 1000PF	K	
C99 ,100			CF92FV1H103J	MF 0.010UF	J	
C111-113			CK45FF1H103Z	CERAMIC 0.010UF	Z	
C114 ,115			CC45FSL1H221J	CERAMIC 220PF	J	
C116 ,117		*	C90-1963-15	ELECTRØ 5600UF	42WV	2
C116 ,117		*	C90-1968-15	ELECTRØ 6800UF	50WV	3
C118			CE04KW1E102M	ELECTRØ 1000UF	25WV	
C119			CK45FF1H103Z	CERAMIC 0.010UF	Z	

L:Scandinavia K:USA P:Canada 3: KA-3050R  
 Y:PX(Far East, Hawaii) T:England E:Europe 2: KA-2050R  
 Y:AAFES(Europe) X:Australia M:Other Areas △ indicates safety critical components.

\* New Parts

Parts without Parts No. are not supplied.

Les articles non mentionnés dans le Parts No. ne sont pas fournis.

Teile ohne Parts No. werden nicht geliefert.

No. 4

Ref. No. 参照番号	Address 位置	New Parts 新	Parts No. 部品番号	Description 部品名 / 規格	Desti- nation 向	Re- marks 備考
C120			CF92FV1H104J	MF 0.10UF J		
C121			CE04KW1V100M	ELECTRO 10UF 35WV		
C122			CE04KW1H010M	ELECTRO 1.0UF 50WV		
C123			CE04KW1A470M	ELECTRO 47UF 10WV		
C124			CK45FF1H223Z	CERAMIC 0.022UF Z		
C125-127			CE04KW1V100M	ELECTRO 10UF 35WV	ELTXM	
C128			CK45FF1H103Z	CERAMIC 0.010UF Z		
C129			C90-1917-05	ELECTRO 100UF 16WV		
C130			CE04KW1H010M	ELECTRO 1.0UF 50WV		
C131,132			CF92FV1H103J	MF 0.010UF J		
C133			CE04KW1H010M	ELECTRO 1.0UF 50WV	ELTXM	
C134			CK45FF1H103Z	CERAMIC 0.010UF Z		
C135			CF92FV1H103J	MF 0.010UF J		
C136,137		*	C90-1971-05	ELECTRO 10UF 50WV		
C138,139			CE04KW1E101M	ELECTRO 100UF 25WV		
C140,141			CE04KW1C470M	ELECTRO 47UF 16WV		
C142,143			CE04KW1H101M	ELECTRO 100UF 50WV		
C144,145			CF92FV1H103J	MF 0.010UF J		
C146,147			CC45FSL1H101J	CERAMIC 100PF J		
C148,149			CE04KW1A101M	ELECTRO 100UF 10WV		
C150,151			CE04KW1V100M	ELECTRO 10UF 35WV	ELTXM	3
C152,153			CE04KW1E221M	ELECTRO 220UF 25WV		
C154			CK45FF1H103Z	CERAMIC 0.010UF Z		
C155,156			CE04KW1V100M	ELECTRO 10UF 35WV		
C157,158			CE04KW1H010M	ELECTRO 1.0UF 50WV		
C159			CC45FSL1H221J	CERAMIC 220PF J		
C160			CE04KW1H010M	ELECTRO 1.0UF 50WV		
J1			E11-0188-05	MINIATURE PHONE JACK SYNCRO		
J2			E11-0208-05	PHONE JACK PHONES		
J3			E13-0235-05	PHONE JACK PHONE		
J4			E13-0634-05	PHONE JACK CD/TUNER/AUX		
J5			E13-0820-05	PHONE JACK TAPE/DAT MONITOR		
J7		*	E70-0018-05	SCREW TERMINAL BOARD SPEAKRES	ETXMP	
J7		*	E70-0019-05	SCREW TERMINAL BOARD SPEAKERS	L	
F4 ,5			F04-5022-05	FUSE (UL) (125V 5A UL)	P	2
F4 ,5			F05-6029-05	FUSE (UL) (125V 6A)	P	3
F6			F04-1026-05	FUSE (UL) (250V 1A)	P	
F6			F06-1022-05	FUSE (SEMKO) (250V T1A)	ELTXM	
-			J11-0098-05	WIRE CLAMPER	P	
CN7 -12			J13-0075-05	FUSE CLIP	ELTXM	
CN11,12			J13-0075-05	FUSE CLIP		
L1 ,2			L40-1011-47	SMALL FIXED INDUCTOR(100UH,K)		3
L3 ,4			L39-0085-05	PHASE COMPENSATION COIL		
L11 ,12			L40-1011-17	SMALL FIXED INDUCTOR(100UH,K)		
L15 ,16			L40-2211-17	SMALL FIXED INDUCTOR(220UH,K)		
CP1 ,2			R90-0187-05	MULTI-COMP 0.22X2 K 5W		2
R23 ,24			RN14BK2C2613FTS	RN 261K F 1/6W		3
R23 ,24			RN14BK2C8252FTS	RN 82.5K F 1/6W		3
R25 ,26			RN14BK2C6811FTS	RN 6.81K F 1/6W		3
R111,112			RD14AB2E472JTS	FL-PROOF RD 4.7K J 1/4W		
R113-118			RD14AB2E680JTS	FL-PROOF RD 68 J 1/4W		
R119,120			RD14AB2E100JTS	FL-PROOF RD 10 J 1/4W		
R129-132			RD14AB2E101JTS	FL-PROOF RD 100 J 1/4W		

L:Scandinavia K:USA P:Canada  
Y:PX(Far East, Hawaii) T:England E:Europe  
Y:AAFES(Europe) X:Australia M:Other Areas

3: KA-3050R  
2: KA-2050R

△ indicates safety critical components

\* New Parts

Parts without Parts No. are not supplied.

Les articles non mentionnés dans le Parts No. ne sont pas fournis.

Teile ohne Parts No. werden nicht geliefert.

No. 5

Ref. No. 参照番号	Address 位置	New Parts 新	Parts No. 部品番号	Description 部品名 / 規格	Desti- nation 向	Re- marks 備考
R133,134			RD14AB2E332JTS	FL-PROOF RD 3.3K J 1/4W		
R135,136			RD14AB2E102JTS	FL-PROOF RD 1.0K J 1/4W		
R141-144			RS14GB3A100JKW	FL-PROOF RS 10 J 1W		
R145,146		*	RS14GB3A8R2JKW	FL-PROOF RS 8.2 J 1W		
R147,148			RS14DB3D151JTE	FL-PROOF RS 150 J 2W		
R167			RS14DB3A471JTE	FL-PROOF RS 470 J 1W		2
R167			RS14DB3A821JTE	FL-PROOF RS 820 J 1W		3
R168			RS14DB3A330JTE	FL-PROOF RS 33 J 1W		
R173			RD14AB2E680JTS	FL-PROOF RD 68 J 1/4W		
R179			RD14AB2E470JTS	FL-PROOF RD 47 J 1/4W		
R181			RD14AB2E332JTS	FL-PROOF RD 3.3K J 1/4W		2
R181			RD14AB2E392JTS	FL-PROOF RD 3.9K J 1/4W		3
R191,192		*	RS14GB3D331JKW	FL-PROOF RS 330 J 2W		
R193,194			RD14AB2E392JTS	FL-PROOF RD 3.9K J 1/4W		2
R193,194			RD14AB2E472JTS	FL-PROOF RD 4.7K J 1/4W		3
R197			RD14AB2E472JTS	FL-PROOF RD 4.7K J 1/4W		
R211,212			RS14DB3A821JTE	FL-PROOF RS 820 J 1W		3
VR1 ,2			R12-1616-05	TRIMMING POT.(1K) IDLEING		
VR11		*	R29-5068-05	POTENTIOMETER(100K) VOLUME		
VR12			R05-5037-05	POTENTIOMETER(200K) BALANCE		
K1			S76-0005-05	MAGNETIC RELAY		
K2			S76-0015-05	MAGNETIC RELAY		
S1		*	S68-0010-05	PUSH SWITCH	SPEAKERS A/B	
S2			S40-6035-05	PUSH SWITCH	MM/MC	3
D1 -30			HSS104	DIODE		
D1 -30			1SS133	DIODE		
D31 ,32			HSS104A	DIODE		
D31 ,32			1SS131	DIODE		
D51			D5SBA20F03	DIODE		
D51			RBV-602LFA	DIODE		
D52 -55			SS688B	DIODE		
D56 ,57			HSS104	DIODE		
D56 ,57			1SS133	DIODE		
D58 ,59			HSS104A	DIODE		
D58 ,59			1SS131	DIODE		
D60			HZ55.1S(B2)	ZENER DIODE		
D60			RD5.1JS(B2)	ZENER DIODE		
D61 ,62			HZ57.5S(B)	ZENER DIODE		
D61 ,62			RD7.5JS(B)	ZENER DIODE		
D63 -69			HSS104	DIODE		
D63 -69			1SS133	DIODE		
D70 -74			HZ57.5S(B)	ZENER DIODE		
D70 -74			RD7.5JS(B)	ZENER DIODE		
D75			HZ520S(B)	ZENER DIODE		
D75			RD20JS(B)	ZENER DIODE		
D76			HZ55.1S(B2)	ZENER DIODE		
D76			RD5.1JS(B2)	ZENER DIODE		
D77 -84			HSS104	DIODE		
D77 -84			1SS133	DIODE		
D85			HZ57.5S(B)	ZENER DIODE		
D85			RD7.5JS(B)	ZENER DIODE		
IC1			NJM4565D	IC(OP AMP X2)		3
IC1			NJM4580D-D	IC(OP AMP X2)		2
IC2			LC7821N	IC(FUNCTION CONTROL SWITCH)		

L:Scandinavia K:USA P:Canada  
Y:PX(Far East, Hawaii) T:England E:Europe  
Y:AAFES(Europe) X:Australia M:Other Areas

3: KA-3050R  
2: KA-2050R

△ indicates safety critical components

PARTS LIST

KA-2050R/3050R

\* New Parts

Parts without Parts No. are not supplied.

Les articles non mentionnés dans le Parts No. ne sont pas fournis.

Teile ohne Parts No. werden nicht geliefert.

No. 6

Ref. No. 参照番号	Address 位置	New Parts 新	Parts No. 部品番号	Description 部品名 / 規格	Desti- nation 仕向	Re- marks 備考
IC3 IC4 IC5 IC6 IC6			NJM4580D-D TC9163N TA8409S TA7805S UPC7805AHF	IC(OP AMP X2) IC(BILATERAL SWITCH X16) IC(MOTOR CONTROL) IC(VOLTAGE REGULATOR/ +5V) IC(VOLTAGE REGULATOR/ +5V)		
IC7 Q1 -4 Q1 -4 Q5 -10 Q11 -14			NJM4565D-D 2SK170(BL) 2SK170(V) 2SC2878(B) 2SC1845(F, E)	IC(OP AMP X2) FET FET TRANSISTOR TRANSISTOR		3 3
Q15 -18 Q19 ,20 Q21 ,22 Q23 ,24 Q23 ,24			2SA992(F, E) 2SC1845(F, E) 2SC4137(V, W) 2SC2458(Y, GR) 2SC3311A(Q, R)	TRANSISTOR TRANSISTOR TRANSISTOR TRANSISTOR TRANSISTOR		
Q51 Q51 Q52 ,53 Q52 ,53 Q54 ,55			2SA1048(Y, GR) 2SA1309A(Q, R) 2SC2458(Y, GR) 2SC3311A(Q, R) 2SC2003(L, K)	TRANSISTOR TRANSISTOR TRANSISTOR TRANSISTOR TRANSISTOR		
Q56 Q56 Q57 ,58 Q57 ,58 Q59			DTA124ES UN4112 DTC124ES UN4212 DTA124ES	DIGITAL TRANSISTOR DIGITAL TRANSISTOR DIGITAL TRANSISTOR DIGITAL TRANSISTOR DIGITAL TRANSISTOR		
Q59 Q60 Q61 Q62 ,63			UN4112 2SD863(B, F) 2SB764(B, F) 2SD863(B, F)	DIGITAL TRANSISTOR TRANSISTOR TRANSISTOR TRANSISTOR		
<b>CONTROL UNIT (X11-32XX-XX)</b>						
D1 D14 -22			B30-1291-05 B30-1291-05	LED(LN21CPSLX(V)-(TA4)) LED(LN21CPSLX(V)-(TA4))		
C1 ,2 C3 -8 C9 -12 C13 -16 C17 -20		*	CE04KW1HR33M CF92FV1H101K C90-1969-05 C90-1970-05 CF92FV1H223J	ELECTRO 0.33UF 50WV MF 100PF K ELECTRO 0.33UF 50WV ELECTRO 10UF 35WV MF 0.022UF J		
C21 ,22 C23 ,24 C51 C52 C53			CE04KW1H010M CF92FV1H561J CE04KW1E470M CF92FV1H103J CE04KW1E470M	ELECTRO 1.0UF 50WV MF 560PF J ELECTRO 47UF 25WV MF 0.010UF J ELECTRO 47UF 25WV		
C54 C55 ,56 C57 C58 C59			CF92FV1H103J CE04KW1HR33M C90-3244-05 CK45FF1H103Z C90-3256-05	MF 0.010UF J ELECTRO 0.33UF 50WV ELECTRO 10UF 35WV CERAMIC 0.010UF Z ELECTRO 4.7UF 50WV		
C60 C61 C62 C63 C64			C90-3253-05 C90-3244-05 CE04KW1H010M CK45FF1H103Z CE04KW1A101M	ELECTRO 1UF 50WV ELECTRO 10UF 35WV ELECTRO 1.0UF 50WV CERAMIC 0.010UF Z ELECTRO 100UF 10WV		
C65 C66 ,67			C90-1827-05 C91-1439-05	BACKUP 0.047F 5.5WV FILM 0.01UF 250VAC		

L:Scandinavia

K:USA

P:Canada

3 : KA-3050R

Y:PX(Far East, Hawaii)

T:England

E:Europe

2 : KA-2050R

Y:AAFES(Europe)

X:Australia

M:Other Areas

△ indicates safety critical components.

No. 7

\* New Parts

Parts without Parts No. are not supplied.

Les articles non mentionnés dans le Parts No. ne sont pas fournis.

Teile ohne Parts No. werden nicht geliefert.

Ref. No. 参照番号	Address 位置	New Parts 新	Parts No. 部品番号	Description 部品名 / 規格	Desti- nation 仕向	Re- marks 備考
△ J1 △ J2 △ J3 -5		*	E03-0131-05 E03-0111-05 E03-0109-05	AC OUTLET AC OUTLET AC OUTLET		ELM P T
△ F1 △ F1 △ F1 △ F1 ,2 △ F1 ,2 △ F3			F04-2025-05 F05-1623-05 F05-4028-05 F06-1022-05 F05-1623-05 F06-1022-05 F05-2525-05	FUSE (UL) (250V 2A) FUSE (SEMKO) (250V T1.6A) FUSE (UL) (125V 4A) FUSE (SEMKO) (250V T1A) FUSE (SEMKO) (250V T1.6A) FUSE (SEMKO) (250V T1A) FUSE (SEMKO) (250V T2.5A)		P 2 ELTX 3 P 3 ELTX 2 M 3 M 2 EL
△ CN1 -4 △ CN1 ,2 CN5 ,6			J13-0075-05 J13-0075-05 J13-0075-05	FUSE CLIP FUSE CLIP FUSE CLIP		M ELTXP EL
L1 ,2 X1			L40-1021-14 L78-0209-05	SMALL FIXED INDUCTOR(1.0MH,K) RESONATOR 4.194MHZ		
R89 VR1 ,2			RD14AB2E680JTS R06-3061-05	FL-PROOF RD 68 J 1/4W POTENTIOMETER BASS, TRESLE		
K1 S1 -5 S1 ,2 S4 ,5 △ S7			S76-0009-05 S40-1064-05 S40-1064-05 S40-1064-05 S31-2322-05	MAGNETIC RELAY PUSH SWITCH KEY BOARD PUSH SWITCH POWER, TAPE2/DAT PUSH SWITCH SOURCE DIR, LOUDNES SLIDE SWITCH VOLTAGE SELECTOR		3 2 2 M
S6		*	T99-0526-05	ROTARY ENCODER INPUT SELECTOR		
D3 -8 D3 -8 D9 D9 D10 -13			HSS104 1SS133 HZS5.1S(B2) RDS.1JS(B2) HSS104	DIODE DIODE ZENER DIODE ZENER DIODE DIODE		
D10 -13 D23 D23 D23 IC1 IC2			1SS133 HSS104 1SS133 UPD75004CU-145 NJM4565D-D	DIODE DIODE DIODE IC(MICROPROCESSOR) IC(OP AMP X2)		
IC3 Q1 Q1 Q2			PST529C 2SC2458(Y, GR) 2SC3311A(Q, R) 2SC2003(L, K)	IC(SYSTEM RESET) TRANSISTOR TRANSISTOR TRANSISTOR		
A1			W02-1046-05	ELECTRIC CIRCUIT MODULE		

L:Scandinavia

K:USA

P:Canada

3 : KA-3050R

Y:PX(Far East, Hawaii)

T:England

E:Europe

2 : KA-2050R

Y:AAFES(Europe)

X:Australia

M:Other Areas

△ indicates safety critical components.

## SPECIFICATIONS (For U.K. and Europe)

### KA-3050R

<b>Continuous rated power output</b>	
(DIN) 1 kHz, at 8 Ω	55 W + 55 W
at 4 Ω	70 W + 70 W
(IEC/NF) From 63 Hz to 12,500 Hz, 0.7% T.H.D.	
at 8 Ω	55 W + 55 W
at 4 Ω	70 W + 70 W
<b>Dynamic power</b>	65 W (8 Ω)
	70 W (6 Ω)
	85 W (4 Ω)
	100 W (2 Ω)
<b>Damping factor</b>	40 (50 Hz)
<b>Total harmonic distortion</b>	0.05%
	(20 Hz ~ 20,000 Hz, 45 W, 8 Ω)
	0.02% (1 kHz, 45 W, 8 Ω)
<b>Intermodulation distortion</b>	0.05% (45 W, 8 Ω)
	(70 Hz : 7 kHz = 4:1)
<b>Frequency response</b>	
CD	5 Hz ~ 90 kHz, +0 dB, -3 dB
PHONO 'RIAA' response	20 Hz ~ 20 kHz, +0.3 dB, -0.3 dB
<b>Maximum input level</b>	
PHONO (MM)	130 mV, 0.5% T.H.D. at 1 kHz
PHONO (MC)	10 mV, 0.5% T.H.D. at 1 kHz
<b>Signal to noise ratio</b>	
PHONO (MM)	87 dB (IHF '66)
	82 dB (IHF '78)
PHONO (MC)	67 dB (IHF '66)
	75 dB (IHF '78)
CD/TUNER/AUX/TAPE	101 dB (IHF '66)
	85 dB (IHF '78)
PHONO (MM)	60 dB (DIN, 50 mW output)
CD/TUNER/AUX/TAPE	60 dB (DIN, 50 mW output)
<b>Input sensitivity/impedance</b>	
PHONO (MM)	2.5 mV/47 kΩ
PHONO (MC)	0.2 mV/100 Ω
CD/TUNER/AUX/TAPE	200 mV/47 kΩ
<b>Tone control</b>	
BASS	±10 dB (at 100 Hz)
TREBLE	±10 dB (at 10 kHz)
<b>Loudness control</b>	
VOLUME at -30 dB level	+6 dB (100 Hz), +3 dB (10 kHz)
<b>Output level/impedance</b>	
TAPE REC	200 mV/1 kΩ
<b>General</b>	
<b>Power consumption</b>	160 W
<b>AC outlets</b>	
SWITCHED	3; (Total 200 W max.)
<b>Dimensions</b>	
	W: 440 mm (17-5/16")
	H: 136 mm (5-3/8")
	D: 350 mm (13-3/4")
<b>Weight (net)</b>	6.9 kg (15.2 lb)

### KA-2050R

<b>Continuous rated power output</b>	
(DIN) 1 kHz, at 8 Ω	35 W + 35 W
at 4 Ω	45 W + 45 W
(IEC/NF) From 63 Hz to 12,500 Hz, 0.7% T.H.D.	
at 8 Ω	35 W + 35 W
at 4 Ω	40 W + 40 W
<b>Dynamic power</b>	45 W (8 Ω)
	50 W (6 Ω)
	60 W (4 Ω)
	70 W (2 Ω)
<b>Damping factor</b>	40 (50 Hz)
<b>Total harmonic distortion</b>	0.05%
	(20 Hz ~ 20,000 Hz, 30 W, 8 Ω)
	0.02% (1 kHz, 30 W, 8 Ω)
<b>Intermodulation distortion</b>	0.05% (30 W, 8 Ω)
	(70 Hz : 7 kHz = 4:1)
<b>Frequency response</b>	
CD	5 Hz ~ 90 kHz, +0 dB, -3 dB
PHONO 'RIAA' response	20 Hz ~ 20 kHz, +0.3 dB, -0.3 dB
<b>Maximum input level</b>	
PHONO (MM)	130 mV, 0.5% T.H.D. at 1 kHz
<b>Signal to noise ratio</b>	
PHONO (MM)	77 dB (IHF '66)
	80 dB (IHF '78)
CD/TUNER/AUX/TAPE	101 dB (IHF '66)
	85 dB (IHF '78)
PHONO (MM)	58 dB (DIN, 50 mW output)
CD/TUNER/AUX/TAPE	60 dB (DIN, 50 mW output)
<b>Input sensitivity/impedance</b>	
PHONO (MM)	2.5 mV/47 kΩ
CD/TUNER/AUX/TAPE	200 mV/47 kΩ
<b>Tone control</b>	
BASS	±10 dB (at 100 Hz)
TREBLE	±10 dB (at 10 kHz)
<b>Loudness control</b>	
VOLUME at -30 dB level	+6 dB (100 Hz), +3 dB (10 kHz)
<b>Output level/impedance</b>	
TAPE REC	200 mV/1 kΩ
<b>General</b>	
<b>Power consumption</b>	120 W
<b>AC outlets</b>	
SWITCHED	3; (Total 200 W max.)
<b>Dimensions</b>	
	W: 440 mm (17-5/16")
	H: 136 mm (5-3/8")
	D: 350 mm (13-3/4")
<b>Weight (net)</b>	6.0 kg (13.2 lb)

# KA-2050R/3050R

## SPECIFICATIONS (For other countries)

### KA-3050R

#### Continuous rated power output

(IHF '66) From 20 Hz to 20,000 Hz 0.05% T.H.D.

at 8  $\Omega$  ..... 45 W + 45 W

(IEC/NF) From 63 Hz to 12,500 Hz, 0.7% T.H.D.

at 8  $\Omega$  ..... 55 W + 55 W

at 4  $\Omega$  ..... 70 W + 70 W

Dynamic power ..... 65 W (8  $\Omega$ )  
70 W (6  $\Omega$ )  
85 W (4  $\Omega$ )  
100 W (2  $\Omega$ )

Damping factor ..... 40 (50 Hz)

Total harmonic distortion ..... 0.05%  
(20 Hz ~ 20,000 Hz, 45 W, 8  $\Omega$ )  
0.02% (1 kHz, 45 W, 8  $\Omega$ )

Intermodulation distortion ..... 0.05% (45 W, 8  $\Omega$ )  
(70 Hz : 7 kHz = 4:1)

#### Frequency response

CD ..... 5 Hz ~ 90 kHz, +0 dB, -3 dB

PHONO 'RIAA' response ..... 20 Hz ~ 20 kHz,  
+0.3 dB, -0.3 dB

#### Maximum input level

PHONO (MM) ..... 130 mV, 0.5% T.H.D. at 1 kHz

PHONO (MC) ..... 10 mV, 0.5% T.H.D. at 1 kHz

#### Signal to noise ratio

PHONO (MM) ..... 87 dB (IHF '66)

82 dB (IHF '78)

PHONO (MC) ..... 67 dB (IHF '66)

75 dB (IHF '78)

CD/TUNER/AUX/TAPE ..... 101 dB (IHF '66)

85 dB (IHF '78)

#### Input sensitivity/impedance

PHONO (MM) ..... 2.5 mV/47 k $\Omega$

PHONO (MC) ..... 0.2 mV/100  $\Omega$

CD/TUNER/AUX/TAPE ..... 200 mV/47 k $\Omega$

#### Tone control

BASS .....  $\pm 10$  dB (at 100 Hz)

TREBLE .....  $\pm 10$  dB (at 10 kHz)

#### Loudness control

VOLUME at -30 dB level ..... +6 dB (100 Hz),

+3 dB (10 kHz)

#### Output level/impedance

TAPE REC ..... 200 mV/1 k $\Omega$

#### General

Power consumption ..... 160 W

#### AC outlets

SWITCHED ..... 3; (Total 200 W max.)

For Australia 2; (Total 200 W max.)

Dimensions ..... W: 440 mm (17-5/16")

H: 136 mm (5-3/8")

D: 350 mm (13-3/4")

Weight (net) ..... 6.9 kg (15.2 lb)

Kenwood follows a policy of continuous advancements in development.  
For this reason specifications may be changed without notice.

Kenwood poursuit une politique de progrès constants en ce qui concerne le développement.  
Pour cette raison, les spécifications sont sujettes à modifications sans préavis.

Kenwood strebt ständige Verbesserungen in der Entwicklung an.  
Daher bleiben Änderungen der technischen Daten jederzeit vorbehalten.

#### Note:

Component and circuitry are subject to modification to insure best operation under differing local conditions. This manual is based on the general market (M) standard, and provides information on regional circuit modification through use of alternate schematic diagrams, and information on regional component variations through use of parts list.

### KA-2050R

#### Continuous rated power output

(IHF '66) From 20 Hz to 20,000 Hz 0.05% T.H.D.

at 8  $\Omega$  ..... 30 W + 30 W

(IEC/NF) From 63 Hz to 12,500 Hz, 0.7% T.H.D.

at 8  $\Omega$  ..... 35 W + 35 W

at 4  $\Omega$  ..... 40 W + 40 W

Dynamic power ..... 45 W (8  $\Omega$ )  
50 W (6  $\Omega$ )  
60 W (4  $\Omega$ )  
70 W (2  $\Omega$ )

Damping factor ..... 40 (50 Hz)

Total harmonic distortion ..... 0.05%  
(20 Hz ~ 20,000 Hz, 30 W, 8  $\Omega$ )  
0.02% (1 kHz, 30 W, 8  $\Omega$ )

Intermodulation distortion ..... 0.05% (30 W, 8  $\Omega$ )  
(70 Hz : 7 kHz = 4:1)

#### Frequency response

CD ..... 5 Hz ~ 90 kHz, +0 dB, -3 dB

PHONO 'RIAA' response ..... 20 Hz ~ 20 kHz,  
+0.3 dB, -0.3 dB

#### Maximum input level

PHONO (MM) ..... 130 mV, 0.5% T.H.D. at 1 kHz

#### Signal to noise ratio

PHONO (MM) ..... 77 dB (IHF '66)

80 dB (IHF '78)

CD/TUNER/AUX/TAPE ..... 101 dB (IHF '66)

85 dB (IHF '78)

#### Input sensitivity/impedance

PHONO (MM) ..... 2.5 mV/47 k $\Omega$

CD/TUNER/AUX/TAPE ..... 200 mV/47 k $\Omega$

#### Tone control

BASS .....  $\pm 10$  dB (at 100 Hz)

TREBLE .....  $\pm 10$  dB (at 10 kHz)

#### Loudness control

VOLUME at -30 dB level ..... +6 dB (100 Hz),

+3 dB (10 kHz)

#### Output level/impedance

TAPE REC ..... 200 mV/1 k $\Omega$

#### General

Power consumption ..... 120 W

#### AC outlets

SWITCHED ..... 3; (Total 200 W max.)

For Australia 2; (Total 200 W max.)

Dimensions ..... W: 440 mm (17-5/16")

H: 136 mm (5-3/8")

D: 350 mm (13-3/4")

Weight (net) ..... 6.0 kg (13.2 lb)

## KENWOOD CORPORATION

Shionogi Shibuya Building, 17-5, 2-chome Shibuya, Shibuya-ku. Tokyo 150. Japan

KENWOOD U.S.A. CORPORATION

2201 East Dominguez Street, Long Beach CA 90810;  
550 Clark Drive, Mount Olive, NJ 07828, U.S.A.

KENWOOD ELECTRONICS CANADA INC.

6070 KESTREL ROAD MISSISSAUGA, ONTARIO L5T 1S8

TRIO-KENWOOD U.K. LIMITED

KENWOOD House, Dwight Road, Watford, Herts., WD1 8EB United Kingdom

KENWOOD ELECTRONICS BENELUX N.V.

Mechelsesteenweg 418 B-1930 Zaventem, Belgium

KENWOOD ELECTRONICS DEUTSCHLAND GMBH

Rembrucker-Str. 15, 6056 Heusenstamm, Germany

TRIO-KENWOOD FRANCE S.A.

13 Boulevard Ney, 75018 Paris, France

KENWOOD LINEAR S.p.A.

20125, MILANO-VIA ARBE, 50, ITALY

KENWOOD ELECTRONICS AUSTRALIA PTY. LTD (A.C.N 001 499 074)

P.O. Box 504, 8 Figtree Drive, Australia Centre, Homebush, N.S.W. 2140, Australia

KENWOOD & LEE ELECTRONICS, LTD.

Wang Kee Building, 4th Floor, 34-37. Connaught Road. Central. Hong Kong